

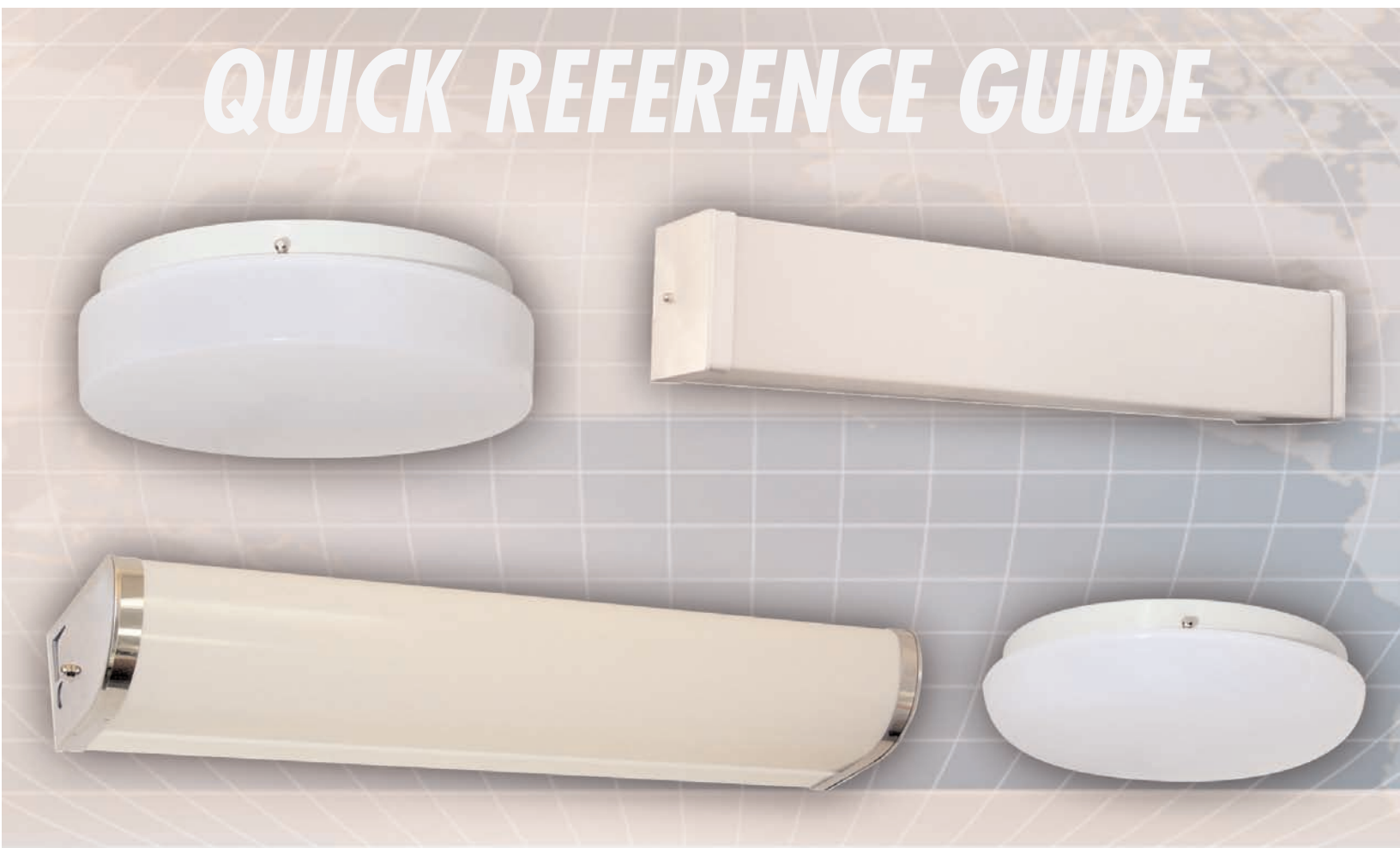

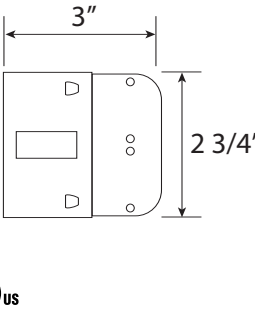







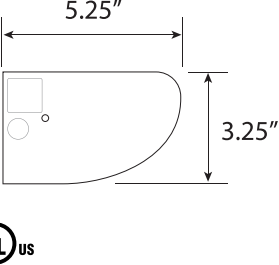

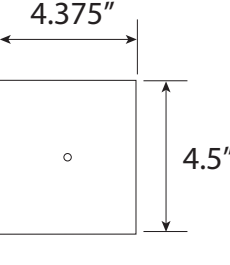
Indoor Fluorescent Fixtures & Strips **from Inter-Global**

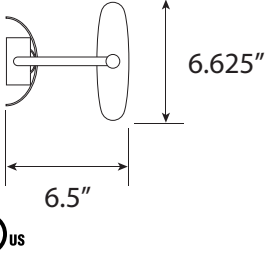
QUICK REFERENCE GUIDE

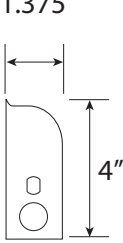

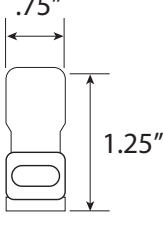



6333 Etzel Avenue • St. Louis, MO 63133-1998 • phone: 314-725-9800 • toll free: 800-325-7364
fax: 314-721-6333 • www.interglobal-inc.com • info@interglobal-inc.com



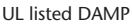

	STYLE#	DESCRIPTION	PAGE
		 UL listed DAMP	
	S2-1X17T8	24.5" LONG, FLUORESCENT ASSEMBLY FOR (1)F17T8 LAMP, WHITE	D1
	S2-2X17T8	24.5" LONG, FLUORESCENT ASSEMBLY FOR (2)F17T8 LAMPS, WHITE	D1
	S3-1X25T8	36.5" LONG, FLUORESCENT ASSEMBLY FOR (1)F25T8 LAMP, WHITE	D1
	S3-2X25T8	36.5" LONG, FLUORESCENT ASSEMBLY FOR (2)F25T8 LAMPS, WHITE	D1
	S4-1X32T8	48.5" LONG, FLUORESCENT ASSEMBLY FOR (1)F32T8 LAMP, WHITE	D1
	S4-2X32T8	48.5" LONG, FLUORESCENT ASSEMBLY FOR (2)F32T8 LAMPS, WHITE	D1
	 HPF, Multi-Volt Ballast  UL listed DAMP		
	HS2-217T8	24.5" LONG , FLUORESCENT FIXTURE FOR (2)F17T8 LAMPS, WHITE/CHROME	D2
	HS3-225T8	36.5" LONG, FLUORESCENT FIXTURE FOR (2)F25T8 LAMPS, WHITE/CHROME	D2
	•HS4-232T8	48.5" LONG, FLUORESCENT FIXTURE FOR (2)F32T8 LAMPS, WHITE/CHROME	D2
	HS-EP-WH	WHITE END CAPS ONLY FOR HS SERIES FLUORESCENT STRIPS (2 PER SET)	D2
	 HPF, Multi-Volt Ballast  UL listed DAMP		
	SQ2-217T8	24.5" LONG, FLUORESCENT FIXTURE FOR (2)F17T8 LAMPS, WHITE	D3
	SQ3-225T8	36.25" LONG, FLUORESCENT FIXTURE FOR (2)F25T8 LAMPS, WHITE	D3
	•SQ4-232T8	48.25" LONG, FLUORESCENT FIXTURE FOR (2)F32T8 LAMPS, WHITE	D3
	  UL listed DAMP AVAILABLE AS SPECIAL ORDER - MOQ 500		
	SV2-217T8	28.25" LONG, FLUORESCENT FIXTURE FOR (2)F17T8 LAMPS, WHITE	D5
	SV3-225T8	40.25" LONG, FLUORESCENT FIXTURE FOR (2)F25T8 LAMPS, WHITE	D5
	•SV4-232T8	52.25" LONG, FLUORESCENT FIXTURE FOR (2)F32T8 LAMPS, WHITE	D5
	Lamp Included  UL listed DAMP		
	UC-115T8	18.25" LONG, FLUORESCENT FIXTURE FOR (1)F15T8 LAMP, WHITE	D6
	UC-117T8	24" LONG, FLUORESCENT FIXTURE FOR (1)F17T8 LAMP, WHITE	D6
PULL CHAIN AVAILABLE ON SPECIAL ORDER			
	 AVAILABLE AS SPECIAL ORDER - MOQ 500		
	SL-215864	14.5" LONG, FLUORESCENT FIXTURE FOR (1)T4/8 WATT LAMP, WHITE	D7
	SL-215850	15.75" LONG, FLUORESCENT FIXTURE FOR (1)T4/12 WATT LAMP, WHITE	D7
	SL-215851	19.5" LONG, FLUORESCENT FIXTURE FOR (1)T4/16 WATT LAMP, WHITE	D7

•Energy Star compliant.

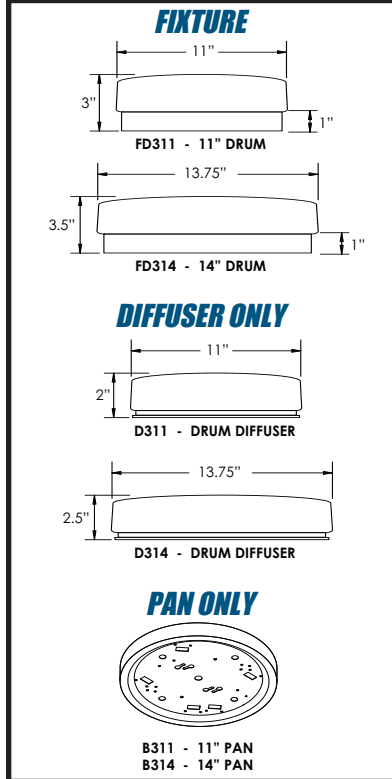

INCANDESCENT
 MAGNETIC FLUORESCENT
 ELECTRONIC FLUORESCENT
 GU-24





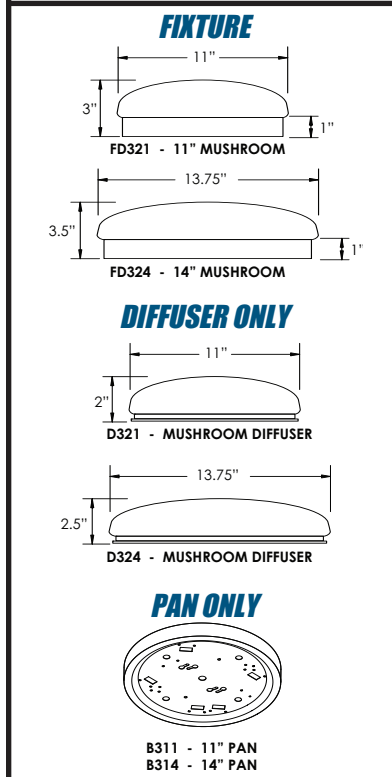

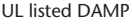



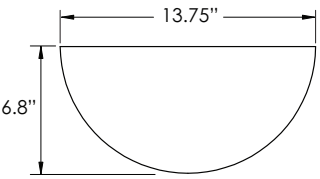

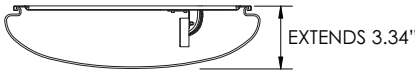

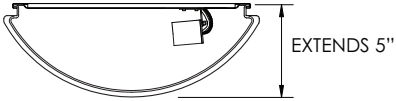
STYLE#	DESCRIPTION	PAGE		
   	<p>AVAILABLE AS SPECIAL ORDER MOQ 500</p>			
	FWSBN-160I		BRUSHED NICKEL, 1-60 WATT INC., FROSTED GLASS	D9
	FWSBR-160I		BRONZE, 1-60 WATT INC., FROSTED GLASS	D9
	•FWSBN-213E		BRUSHED NICKEL, 1-CFQ13W/G24q, FROSTED GLASS	D9
	•FWSBR-213E		BRONZE, 1-CFQ13W/G24q, FROSTED GLASS	D9
	•FWSBN-226E		BRUSHED NICKEL, 1-CFQ26W/G24q, FROSTED GLASS	D9
	•FWSBR-226E		BRONZE, 1-CFQ26W/G24q, FROSTED GLASS	D9

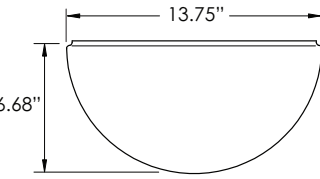

STYLE#	DESCRIPTION	PAGE		
  	<p>AVAILABLE AS SPECIAL ORDER MOQ 100</p>			
	•FD311-G13-WW		11" ROUND, FIXTURE FOR (1)13 WATT GU-24 LAMP INCLUDED	D10
	•FD314-G13-WW		14" ROUND, FIXTURE FOR (1)13 WATT GU-24 LAMP INCLUDED	D10
	•FD311-G213-WW		11" ROUND, FIXTURE FOR (2)13 WATT GU-24 LAMPS INCLUDED	D10
	•FD314-G213-WW		14" ROUND, FIXTURE FOR (2)13 WATT GU-24 LAMPS INCLUDED	D10
	FD311-M213-WW		11" ROUND, MAGNETIC FIXTURE FOR (2)CFT13W/GX23 LAMPS	D10
	FD314-M213-WW		14" ROUND, MAGNETIC FIXTURE FOR (2)CFT13W/GX23 LAMPS	D10
	•FD311-E213-WW		11" ROUND, ELECTRONIC FIXTURE FOR (2)CFQ13W/G24q LAMPS	D10
	•FD314-E213-WW		14" ROUND, ELECTRONIC FIXTURE FOR (2)CFQ13W/G24q LAMPS	D10
	FD311-E22-WW		11" ROUND, ELECTRONIC FIXTURE FOR (1)22 WATT CIRCLINE LAMP	D10
	FD314-E22-WW		14" ROUND, ELECTRONIC FIXTURE FOR (1)22 WATT CIRCLINE LAMP	D10
	FD314-M313-WW		14" ROUND, MAGNETIC FIXTURE FOR (3)CFT13W/GX23 LAMPS	D10
	•FD314-E313-WW		14" ROUND, ELECTRONIC FIXTURE FOR (3)CFQ13W/G24q LAMPS	D10
	•FD314-E226-WW		14" ROUND, ELECTRONIC FIXTURE FOR (2)CFQ26W/G24q LAMPS	D10
	FD314-E32-WW		14" ROUND, ELECTRONIC FIXTURE FOR (1)32 WATT CIRCLINE LAMP	D10
FD314-E54-WW	14" ROUND, ELECTRONIC FIXTURE FOR (1)22 WATT AND (1)32 WATT CIRCLINE LAMP	D10		

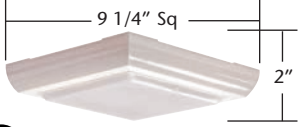

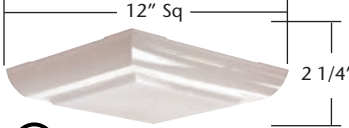
STYLE#	DESCRIPTION	PAGE		
  	<p>AVAILABLE AS SPECIAL ORDER MOQ 100</p>			
	•FD321-G13-WW		11" ROUND, FIXTURE FOR (1)13 WATT GU-24 LAMP INCLUDED	D10
	•FD324-G13-WW		14" ROUND, FIXTURE FOR (1)13 WATT GU-24 LAMP INCLUDED	D10
	•FD321-G213-WW		11" ROUND, FIXTURE FOR (2)13 WATT GU-24 LAMPS INCLUDED	D10
	•FD324-G213-WW		14" ROUND, FIXTURE FOR (2)13 WATT GU-24 LAMPS INCLUDED	D10
	FD321-M213-WW		11" ROUND, MAGNETIC FIXTURE FOR (2)CFT13W/GX23 LAMPS	D10
	FD324-M213-WW		14" ROUND, MAGNETIC FIXTURE FOR (2)CFT13W/GX23 LAMPS	D10
	•FD321-E213-WW		11" ROUND, ELECTRONIC FIXTURE FOR (2)CFQ13W/G24q LAMPS	D10
	•FD324-E213-WW		14" ROUND, ELECTRONIC FIXTURE FOR (2)CFQ13W/G24q LAMPS	D10
	FD321-E22-WW		11" ROUND, ELECTRONIC FIXTURE FOR (1)22 WATT CIRCLINE LAMP	D10
	FD324-E22-WW		14" ROUND, ELECTRONIC FIXTURE FOR (1)22 WATT CIRCLINE LAMP	D10
	FD324-M313-WW		14" ROUND, MAGNETIC FIXTURE FOR (3)CFT13W/GX23 LAMPS	D10
	•FD324-E313-WW		14" ROUND, ELECTRONIC FIXTURE FOR (3)CFQ13W/G24q LAMPS	D10
	•FD324-E226-WW		14" ROUND, ELECTRONIC FIXTURE FOR (2)CFQ26W/G24q LAMPS	D10
	FD324-E32-WW		14" ROUND, ELECTRONIC FIXTURE FOR (1)32 WATT CIRCLINE LAMP	D10
FD324-E54-WW	14" ROUND, ELECTRONIC FIXTURE FOR (1)22 WATT AND (1)32 WATT CIRCLINE LAMP	D10		

	STYLE#	DESCRIPTION	PAGE
 	<p>AVAILABLE AS SPECIAL ORDER MOQ 300</p>  <p>EXTENDS 3.34"</p>  <p>LOW PROFILE HALF MOON WALL SCONCE UL listed DAMP</p> <p>•FM101-G13-WW WHITE, 1-13W GU-24 LAMP INCLUDED, WHITE LENS D11</p> <p>FM101-M13-WW WHITE, 1-CFT13W/GX23, WHITE LENS D11</p> <p>FM101-M213-WW WHITE, 2-CFT13W/GX23, WHITE LENS D11</p> <p>•FM101-E13-WW WHITE, 1-CFQ13W/G24q, WHITE LENS D11</p> <p>•FM101-E213-WW WHITE, 2-CFQ13W/G24q, WHITE LENS D11</p>	<p>AVAILABLE AS SPECIAL ORDER MOQ 300</p>  <p>EXTENDS 5"</p>  <p>DEEP WELL HALF MOON WALL SCONCE UL listed DAMP</p> <p>FM102-I100-WW WHITE, 1-100W INCANDESCENT, WHITE LENS D11</p> <p>•FM102-G13-WW WHITE, 1-13W GU-24 LAMP INCLUDED, WHITE LENS D11</p> <p>FM102-M13-WW WHITE, 1-CFT13W/GX23, WHITE LENS D11</p> <p>FM102-M213-WW WHITE, 2-CFT13W/GX23, WHITE LENS D11</p> <p>•FM102-E13-WW WHITE, 1-CFQ13W/G24q, WHITE LENS D11</p> <p>•FM102-E213-WW WHITE, 2-CFQ13W/G24q, WHITE LENS D11</p>	 
 			
 		<p>9.25" LOW PROFILE UL listed DAMP</p> <p>F5110 CREAM, 1-CFT9W, WHITE or CLEAR LENS D12</p> <p>F5111 CREAM, 2-CFT9W, WHITE or CLEAR LENS D12</p>	
 		<p>12" LOW PROFILE UL listed DAMP</p> <p>F5112 CREAM, 1-CFT13W, WHITE or CLEAR LENS D12</p> <p>F5113 CREAM, 2-CFT13W, WHITE or CLEAR LENS D12</p>	

•Energy Star compliant. INCANDESCENT MAGNETIC FLUORESCENT ELECTRONIC FLUORESCENT GU-24

1-800-325-7364
www.interglobal-inc.com